

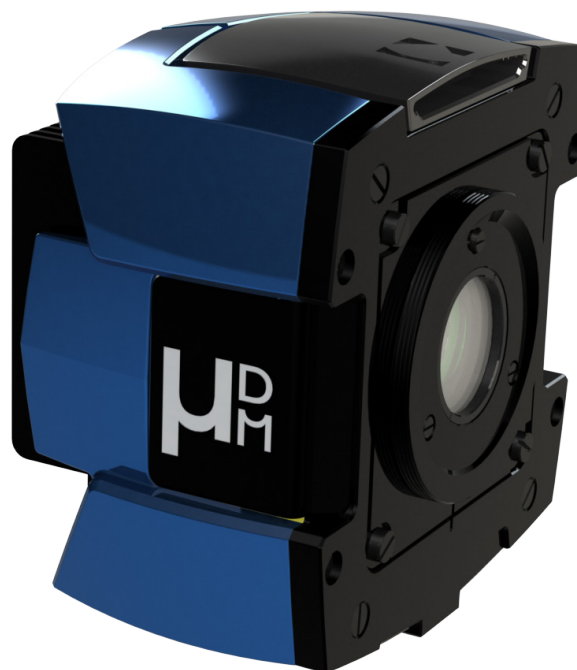

MU-DM

Deformable mirror
The High-end

High dynamic range, linearity & stability
Embedded electronics
High actuator density



Boost your imaging
performance :
Adaptive Optics made
easy and efficient.

APPLICATIONS

- + **Ophthalmology** : Explore retinal cells at high resolution (contact our sister company Imagine Eyes for more informations)
- + **Microscopy** : Image deeper in your sample and/or navigate in 3D (for more details visit mu-Imagine website, our division dedicated to microscopy)
- + **Quantum applications**
- + **Beam shaping**
- + **Laser micromachining**

FEATURES

- + **Fast closed-loop convergence and accurate sensorless correction** with perfect linearity and absence of hysteresis
- + **Preserved photon budget** with achromatic, highly reflective and continuous membrane
- + **Long-term stability** with temporal drift automatic compensation
- + **Large dynamic range** with 50% of actuators stroke still available while generating 40 microns PtV of focus
- + **Fine timing control** with trigger-in and trigger-out features
- + **Easy integration** with electronics embedded in a single-piece design and connection via a USB3 cable
- + **Correction up to 10th Zernike order** thanks to optimized actuator layout

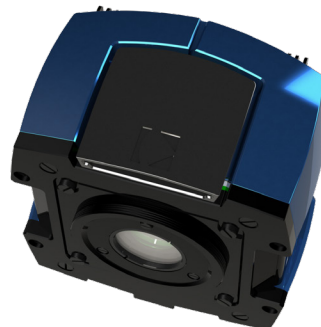
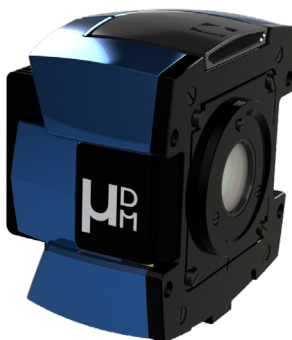

SPECIFICATIONS*

OPTICAL SPECS

Surface quality	7 nm RMS (Optional : down to 4 nm RMS)
Coating	Protected silver
Linearity	> 99.5%
Hysteresis	< 0.1%

OPERATING SPECS

Number of actuators	91
Maximum generated wavefront (PV)	> 10 μm
- 1 actuator	> 50 μm
- 7 actuators	15 mm
Effective diameter	Zernike orders up to 10
Spatial frequency correction	2.4 ms
Rise time	Typically 300 Hz
Max frequency	< 15 nm RMS over 12h
Temporal stability	

MISC

Dimension / Weight	93.8 x 98.3 x 67.2 mm ³ / 185 g
Working temperature	19-25°C
Interface / Power consumption	USB 3.0 / 30 W

OPERATING SYSTEM

Windows 10

*Subject to changes without further notice

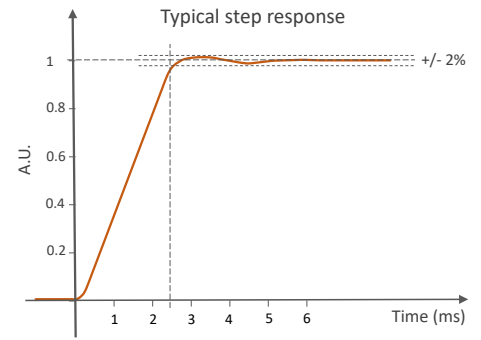

Optimized temporal control achieves a settling time of 2.4 ms with minimal over-shoot (< ±2%)

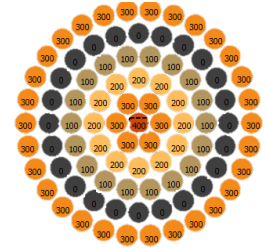

Centro-symmetrical layout is ideal to generate Zernike polynomials in closed-loop and open-loop

High linearity leads to a remarkable behavior as you can see below :
 (A) Input wavefront (B) Results in closed-loop (C) Results in open-loop

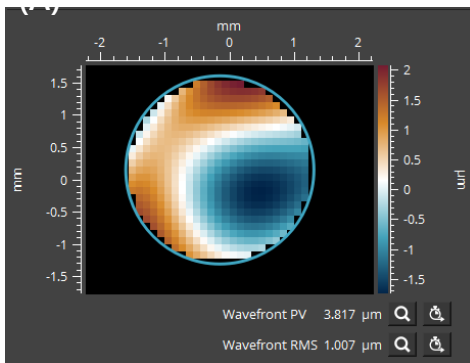

Target wavefront is 1.007 μm RMS
 (combination of Zernike polynomials up to the 4th order)

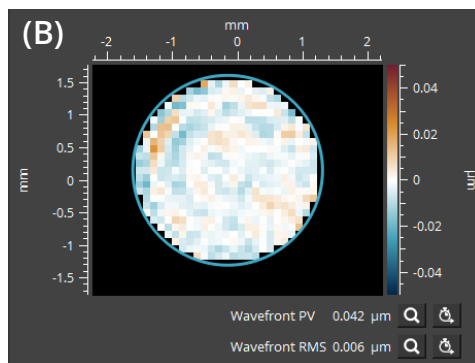

Wavefront error in closed-loop
 WFE = 6 nm RMS

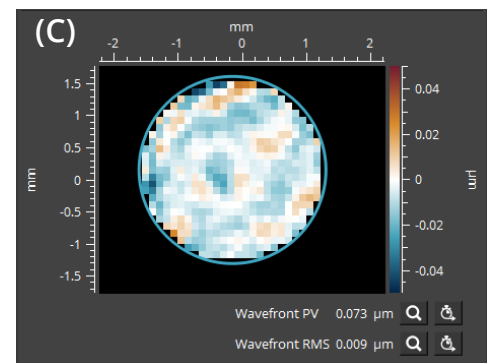

Wavefront error in open-loop
 WFE = 9 nm RMS

DIMENSIONS (mm)

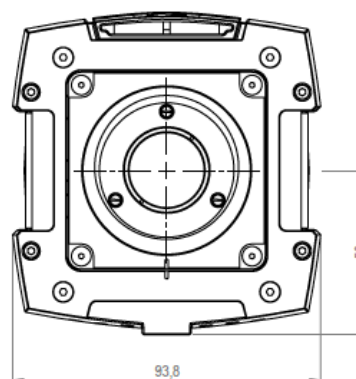
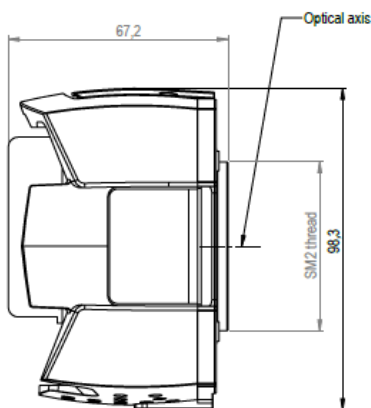

SOFTWARE

WAVETUNE

WAVETUNE is a unique software that seamlessly combines wavefront measurement and correction features with extensive instrument diagnostics.

This software contains all the necessary tools to calibrate the Deformable Mirror (DM). It can also operate the DM in closed-loop with HASO wavefront sensor, as well as in open-loop and perform beam shaping.

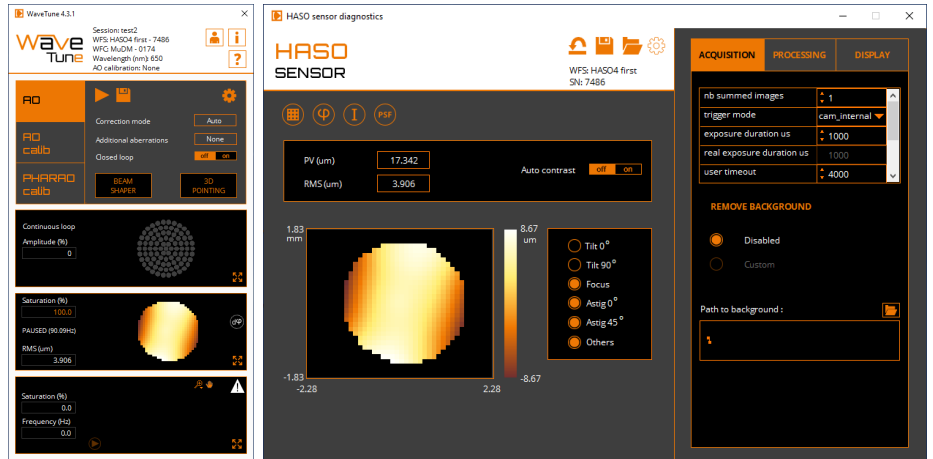

mu-DM Suite

mu-DM Suite is a free software delivered with every mu-DM. It does not require calibration of deformable mirror with a wavefront sensor but with it you can apply a flat shape or first Zernike modes which can be handy for a first, quick alignment of the deformable mirror.

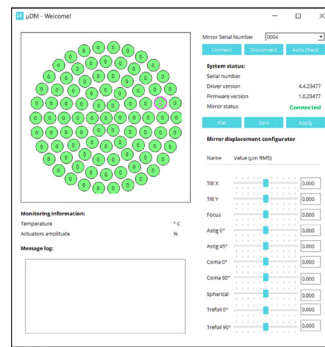

WAVEKIT BIO

WAVEKIT BIO is a Software Development Kit (SDK), available in C++ and Python, specifically designed for microscopy applications. In particular, it contains all the necessary functions to implement sensorless AO, using image-based iterative algorithms (e.g. 3N).

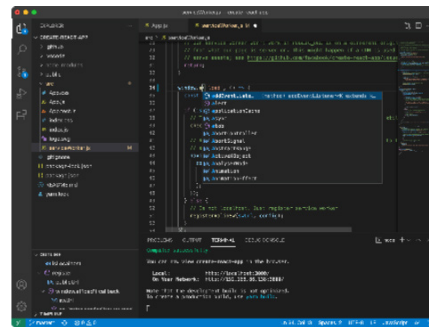

MOUNTING & ACCESSORIES

Several mounting options are available, including adaptors for the most common mechanical stages, to simplify integration of mu-DM into an optical setup.



CONTACTING US

Imagine Optic Headquarters
18, rue Charles de Gaulle
91400 ORSAY · France
Phone +33 (0)1 64 86 15 60
sales@imagine-optic.com
www.imagine-optic.com

